

ARMREST HOLE PATTERN

870-39L

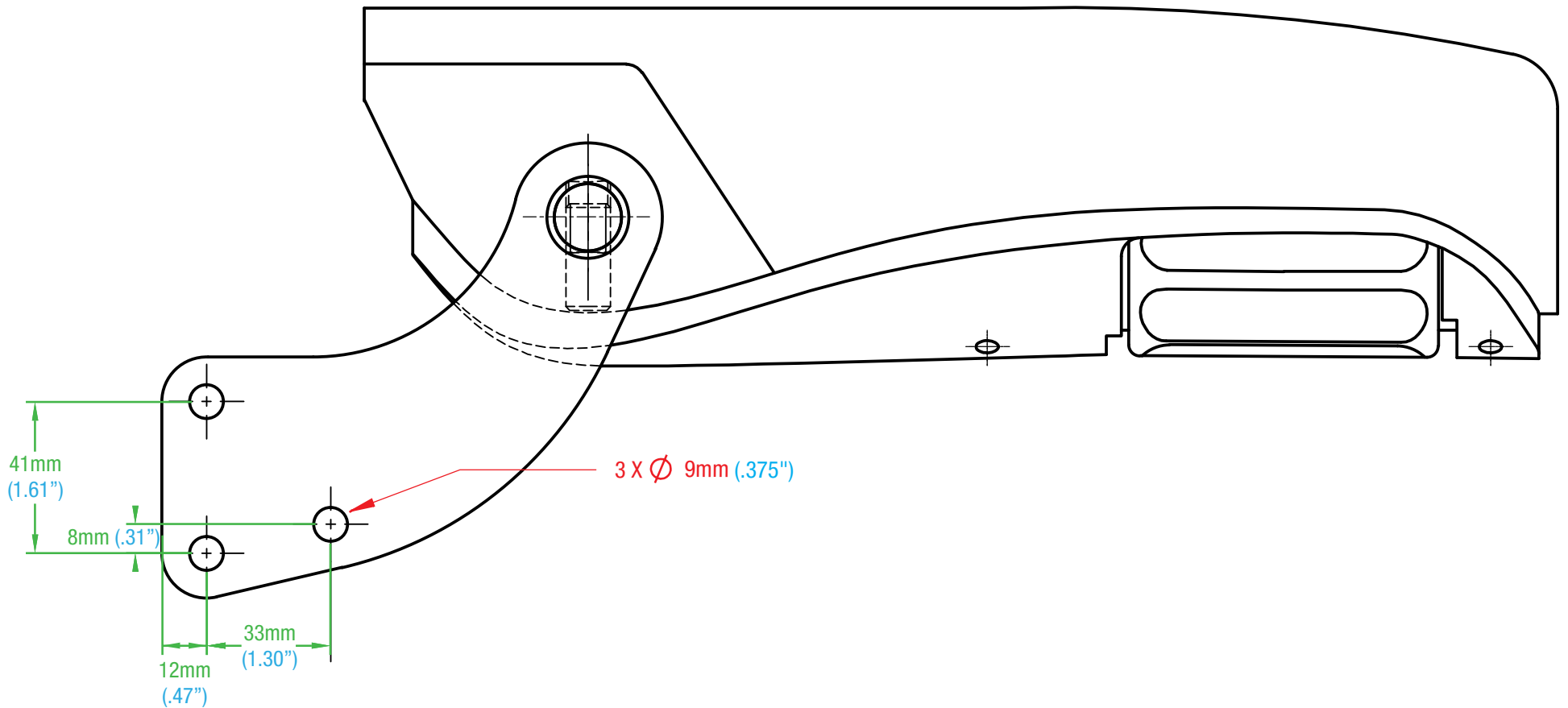

ULTRA SEAT CORPORATION

* Mounting Pattern Dimensions
* Measurements in Inches

PHONE: 1-800-667-7328 • FAX: 1-888-667-7328

ULTRASEAT.COM